

1- Line, Uni-directional, ESD protection diode

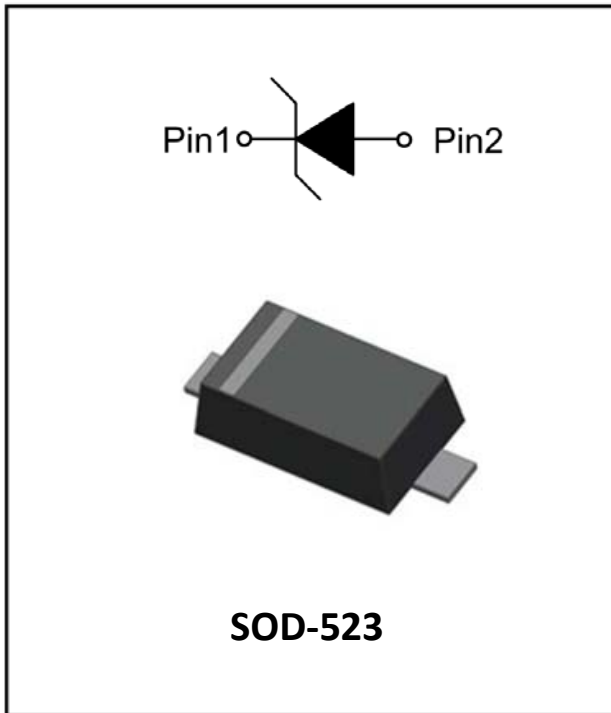

Features

- Transient protection for each line according to IEC61000-4-2(ESD): $\pm 30\text{kV}$ contact, $\pm 30\text{kV}$ air IEC61000-4-5:20A($t_p=8/20\mu\text{s}$)
- Low leakage current
- Ultra low clamping voltage
- RoHS Compliant
- Part no. with suffix "Q" means AEC-Q101 qualified

Applications

- Switches / Buttons
- Test Equipment/Instrumentation
- Point-of-Sale Terminals
- Medical Equipment
- Notebooks / Desktops / Servers
- Computer Peripherals
- CAN Bus protection
- Automotive applications

Mechanical Data

- Package: SOD-523
- Lead Finish: Matte Tin
- Case Material: "Green" Molding Compound
- Moisture Sensitivity: Level 1 per J-STD-020

■ Definitions of electrical characteristics

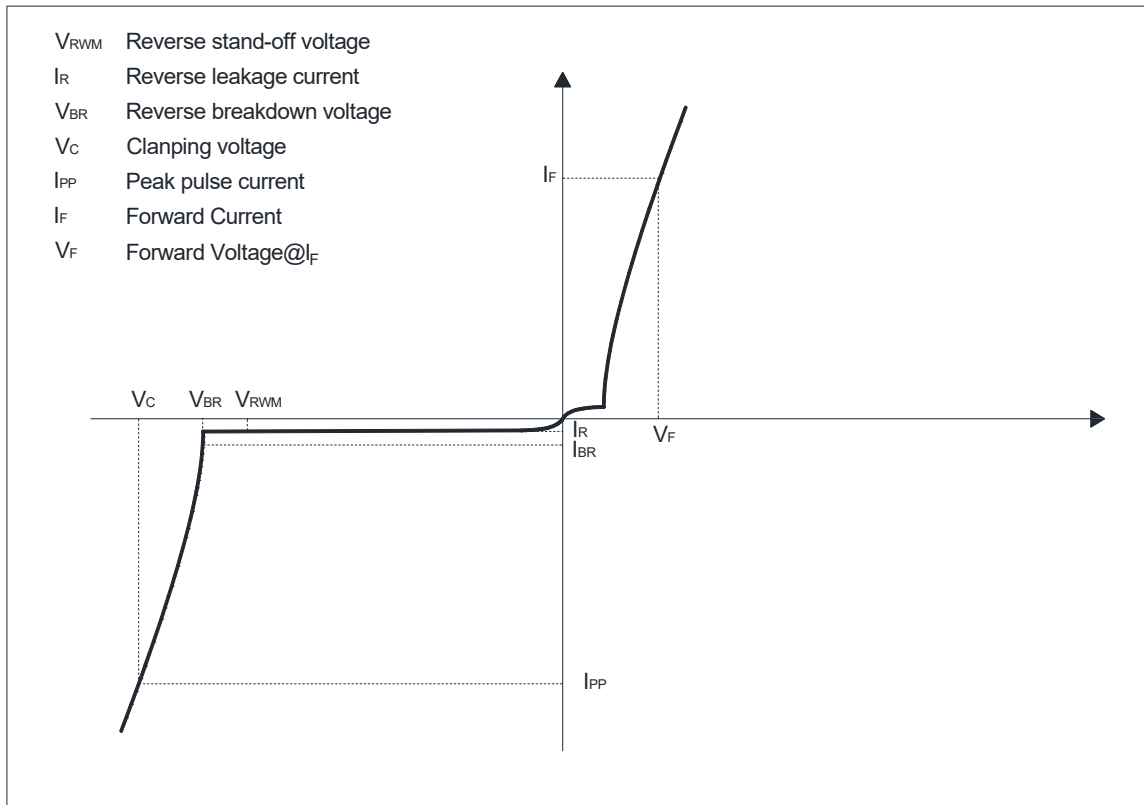



ESD5V0D5Q

■Maximum Ratings

PARAMETER	SYMBOL	LIMITS	UNIT
Peak pulse power ($t_p = 8/20\mu s$)	P_{pk}	300	W
ESD according to IEC61000-4-2 air discharge	V_{ESD}	± 30	KV
ESD according to IEC61000-4-2 contact discharge		± 30	
Junction temperature	T_J	-55~150	$^{\circ}C$
Storage temperature	T_{STG}	-55~150	$^{\circ}C$

Notes:

CAUTION: Stresses above those listed in "Absolute Maximum Ratings" may cause permanent damage to the component. This is a stress only rating and operation of the component at these or any other conditions above those indicated in the operational sections of this specification is not implied.

■Electrical Characteristics ($T_J=25^{\circ}C$)

PARAMETER	Symbol	UNIT	Conditions	Min	Typ	Max
Reverse Standoff Voltage	V_{RWM}	V	$I_R \leq 1\mu A$			5
Reverse breakdown voltage	V_{BR}	V	$I_{BR} = 1mA$	6.2		7.5
Reverse leakage current	I_R	μA	$V_{RWM} = 5V$			1.0
Forward Voltage	V_F	V	$I_F = 10mA$			1.1
Clamping voltage ¹⁾	V_C	V	$I_{PP} = 5A, t_p = 8/20\mu s$			9
			$I_{PP} = 15A, t_p = 8/20\mu s$			12
			$I_{PP} = 20A, t_p = 8/20\mu s$			15
Dynamic resistance ²⁾	R_{DYN}	Ω	TLP, $t_p=100ns$, I/O to Ground		0.1	
Peak Pulse Current	I_{PP}	A	$t_p = 8/20\mu s$			20
Junction capacitance	C_J	pF	$V_R = 0V, f = 1MHz$		140	160

Notes:

(1). Non-repetitive current pulse, according to IEC61000-4-5.

(2). TLP parameter: $Z_0 = 50\Omega$, $t_p = 100ns$, $t_r = 2ns$, averaging window from 60ns to 80ns. R_{DYN} is calculated from 4A to 16A.

■Ordering Information (Example)

PREFERRED P/N	PACKING CODE	UNIT WEIGHT(mg)	MINIMUM PACKAGE(pcs)	INNER BOX QUANTITY(pcs)	OUTER CARTON QUANTITY(pcs)	DELIVERY MODE
ESD5V0D5Q	F2	Approximate 2	8000	80000	320000	7 reel



■ Characteristics (Typical)

Fig.1: Non-Repetitive Peak Pulse Power vs. Pulse Time

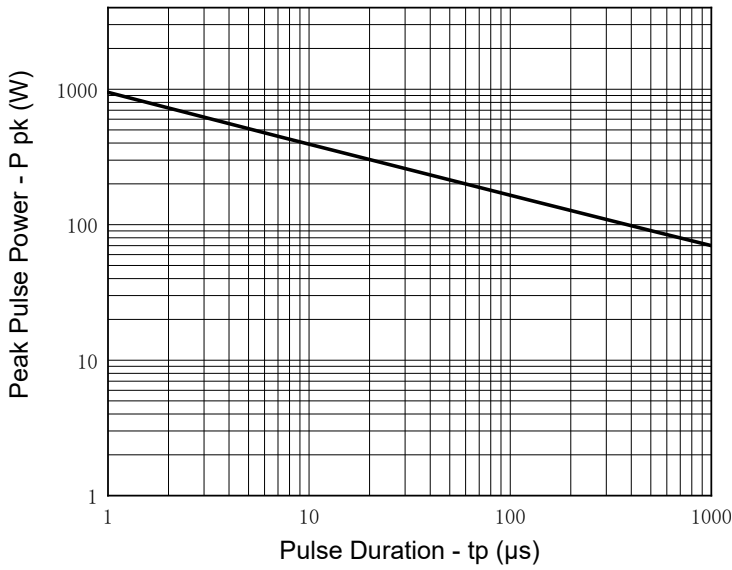

Fig.2: Capacitance vs. Bias

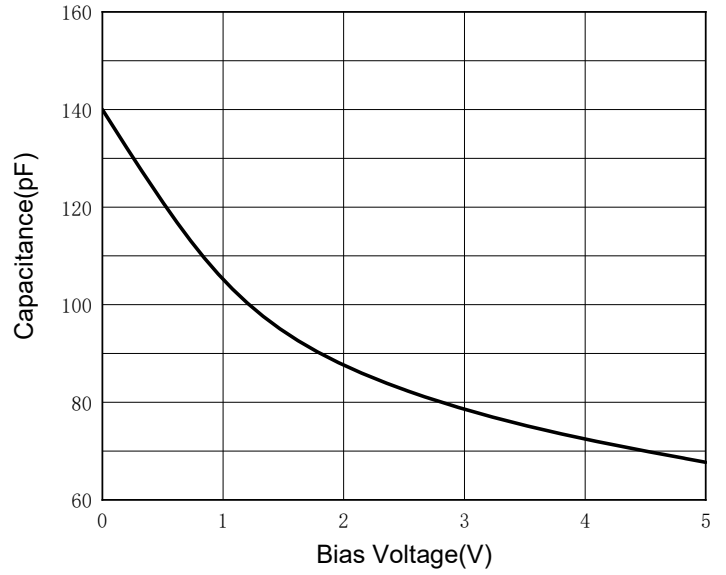

Fig.3: Power Derating Curve

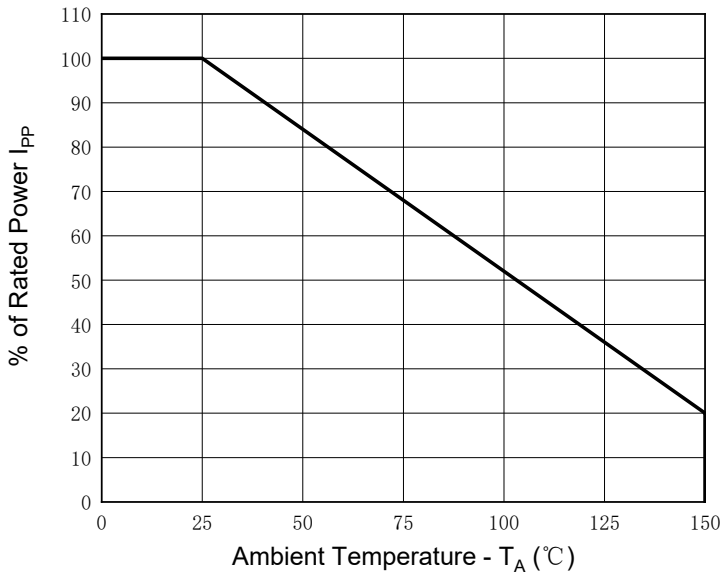

Fig.4: 8/20μs Pulse Waveform

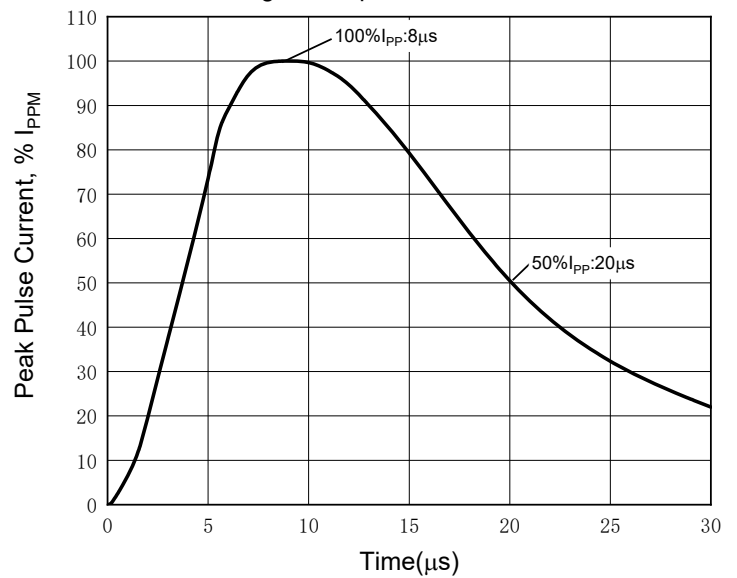
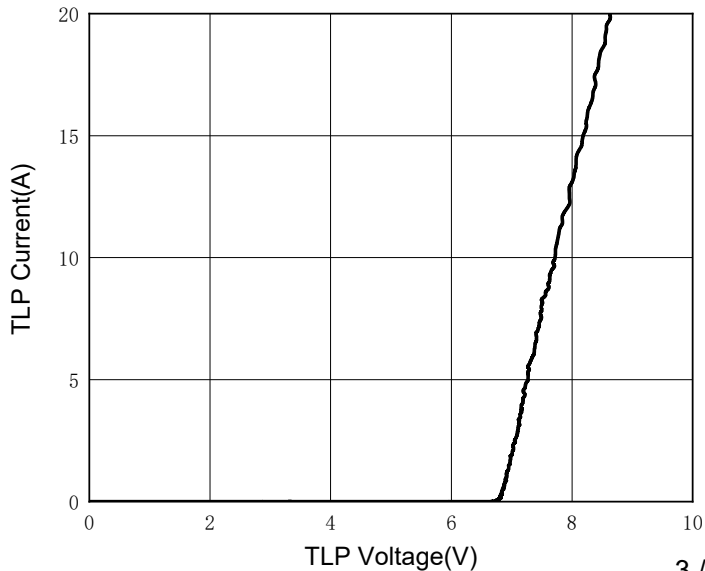

Fig.5: Transmission Line Pulsing (TLP) Plot





ESD5V0D5Q

■ Outline Dimensions

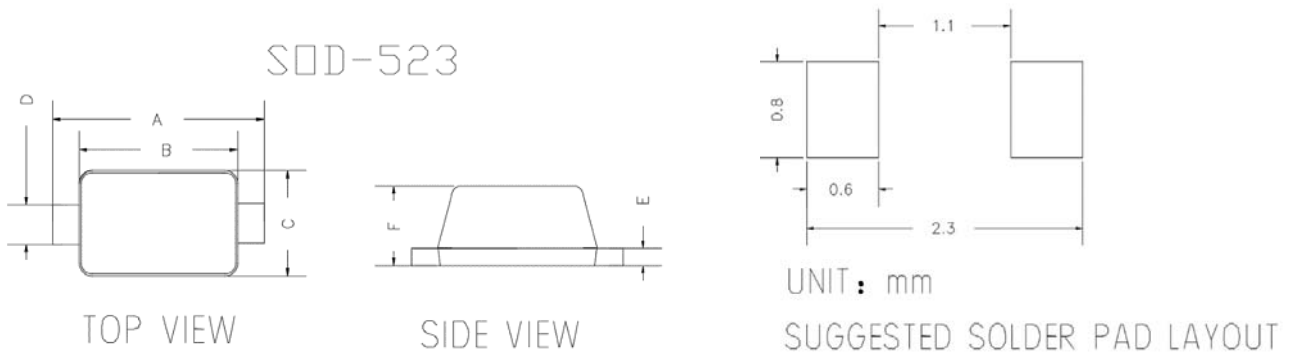

DIMENSIONS				
DIM	INCHES		MM	
	MIN	MAX	MIN	MAX
A	0.059	0.067	1.500	1.700
B	0.043	0.051	1.100	1.300
C	0.028	0.035	0.700	0.900
D	0.010	0.014	0.250	0.350
E	0.002	0.008	0.050	0.200
F	0.020	0.028	0.500	0.700

■ Marking Information

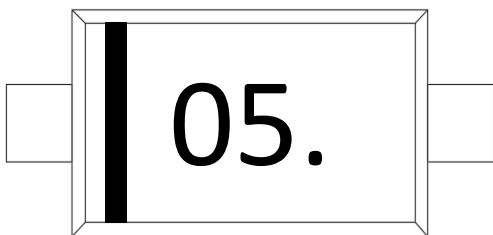

Note:

1. All marking is at middle of the product body
2. All marking is in laser marking
3. Body color: Black



ESD5V0D5Q

Disclaimer

The information presented in this document is for reference only. Yangzhou Yangjie Electronic Technology Co., Ltd. reserves the right to make changes without notice for the specification of the products displayed herein to improve reliability, function or design or otherwise.

The product listed herein is designed to be used with automotive electronics, are not designed for use in medical, life-saving, lifesustaining, or military, Yangjie or anyone on its behalf, assumes no responsibility or liability for any damages resulting from such improper use of sale.

This publication supersedes & replaces all information previously supplied. For additional information, please visit our website [http:// www.21yangjie.com](http://www.21yangjie.com) , or consult your nearest Yangjie's sales office for further assistance.