

## PNP General Purpose Amplifier

### SOT-89

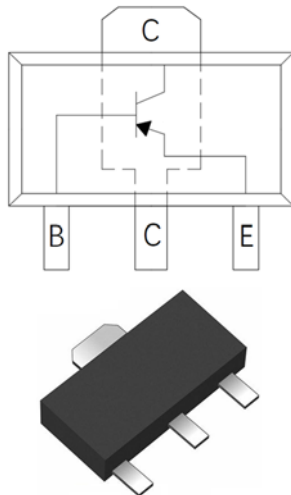

#### Features

- Moisture sensitivity level 1
- Halogen free and RoHS compliant
- Surface mount package ideally suited for automatic insertion

#### Application

- Signal amplification
- Switching circuit

#### Mechanical data

- **Package:** SOT-89
- **Terminals:** Tin plated leads, solderable per J-STD-002 and JESD22-B102

#### ■ Maximum Ratings ( $T_a=25^\circ\text{C}$ Unless otherwise specified)

Item	Symbol	Unit	Conditions	Value
Device marking code				NY
Collector-base voltage	$V_{CBO}$	V	$I_C=-100\mu\text{A}$ , $I_E=0$	-50
Collector-emitter voltage	$V_{CEO}$	V	$I_C=-10\text{mA}$ , $I_B=0$	-50
Emitter-base voltage	$V_{EBO}$	V	$I_E=-100\mu\text{A}$ , $I_C=0$	-5
Collector current	$I_C$	A		-2
Power dissipation	$P_D$	mW		500
Junction temperature	$T_J$	$^\circ\text{C}$		-55 to +150
Storage temperature	$T_{STG}$	$^\circ\text{C}$		-55 to +150



## 2SA1213-Y

### ■ Electrical Characteristics (T<sub>a</sub>=25°C Unless otherwise specified)

Item	Symbol	Unit	Conditions	Min	Typ	Max
Collector-base breakdown voltage	V <sub>(BR)CBO</sub>	V	I <sub>C</sub> =-100μA, I <sub>E</sub> =0	-50		
Collector-emitter breakdown voltage	V <sub>(BR)CEO</sub>	V	I <sub>C</sub> =-10mA, I <sub>B</sub> =0	-50		
Emitter-base breakdown voltage	V <sub>(BR)EBO</sub>	V	I <sub>E</sub> =-100μA, I <sub>C</sub> =0	-5		
Collector-base cut-off current	I <sub>CBO</sub>	μA	V <sub>CB</sub> =-50V			-0.1
Emitter-base cut-off current	I <sub>EBO</sub>	μA	V <sub>EB</sub> =-5V			-0.1
DC current gain	h <sub>FE1</sub>		I <sub>C</sub> =-0.5A V <sub>CE</sub> =-2V	120		240
	h <sub>FE2</sub>		I <sub>C</sub> =-2A V <sub>CE</sub> =-2V	20		
Collector-emitter saturation voltage	V <sub>CE(sat)</sub>	V	I <sub>C</sub> =-1A I <sub>B</sub> =-50mA			-0.5
Base-emitter saturation voltage	V <sub>BE(sat)</sub>	V	I <sub>C</sub> =-1A I <sub>B</sub> =-50mA			-1.2
Transition frequency	f <sub>T</sub>	MHz	V <sub>CE</sub> =-5V, I <sub>C</sub> =-50mA	50		
Collector-base output capacitance	C <sub>ob</sub>	pF	V <sub>CB</sub> =-10V, I <sub>E</sub> =0, f=1MHz		20	

### ■ Thermal Characteristics

Parameter	Symbol	Unit	Value
Thermal resistance, junction-to-ambient	R <sub>θJ-A</sub> <sup>(1)</sup>	°C/W	250
Thermal resistance, junction-to-case	R <sub>θJ-C</sub> <sup>(1)</sup>	°C/W	200

#### Note:

(1) Device mounted on PCB, single-sided copper, with standard footprint



■ Characteristics

Fig 1: Static Characteristics

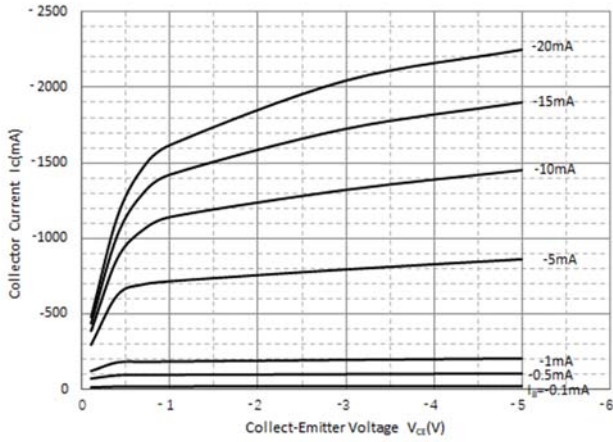

Fig 2: DC Current Gain

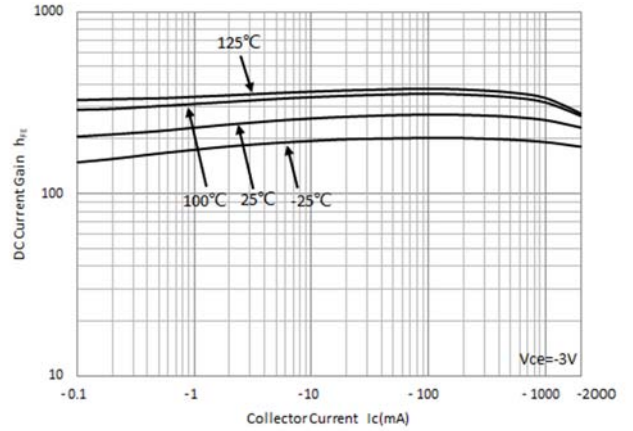

Fig 3: Collector-Emitter Saturation Voltage

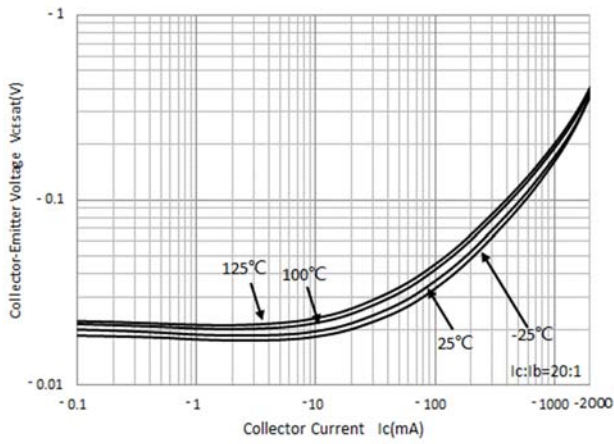

Fig 4: Base-Emitter Saturation Voltage

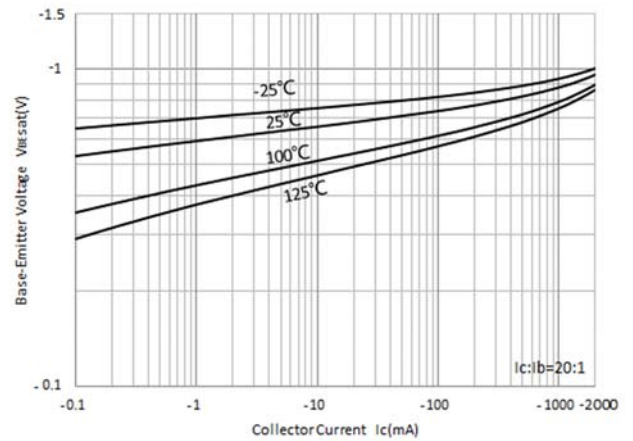

Fig 5: Base-Emitter On Voltage

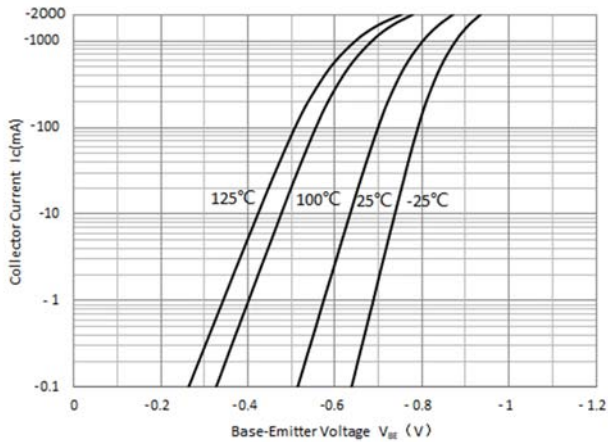
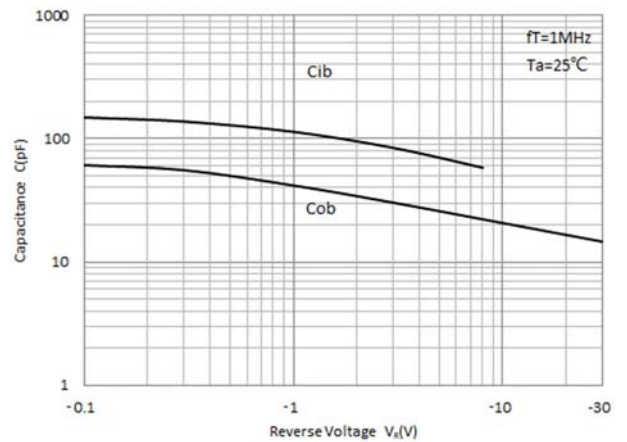
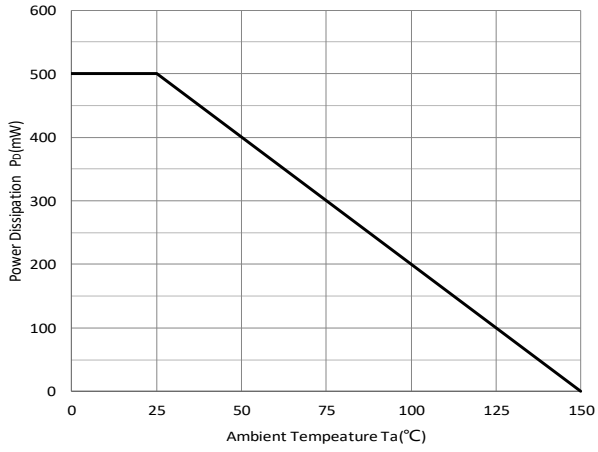

Fig 6: Cob/Cib-VCB/VEB





**Fig 7: P<sub>D</sub>-T<sub>a</sub> Curve**





## 2SA1213-Y

### ■ Ordering Information

Preferred P/N	Packing code	Unit weight(g)	Minimum package(pcs)	Inner box quantity(pcs)	Outer carton quantity(pcs)	Delivery mode
2SA1213	F2	Approximate 0.055	1000	8000	32000	7" reel

### ■ Outline Dimensions

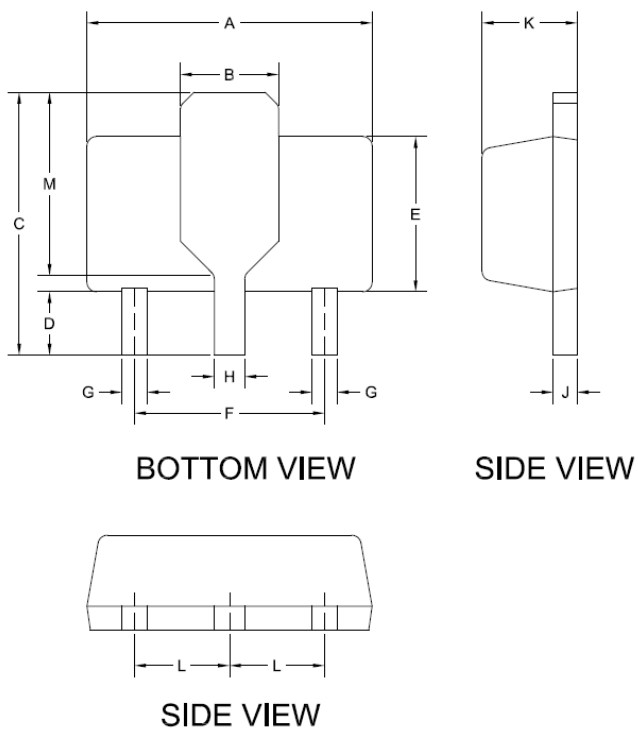

DIM	DIMENSIONS			
	INCHES		MM	
	MIN.	MAX.	MIN.	MAX.
A	0.173	0.181	4.400	4.600
B	0.061 TYP.		1.550 TYP.	
C	0.155	0.167	3.940	4.250
D	0.031	0.047	0.800	1.200
E	0.094	0.102	2.400	2.600
F	0.118 TYP.		3.00 TYP.	
G	0.014	0.019	0.360	0.480
H	0.017	0.022	0.440	0.560
J	0.014	0.017	0.350	0.440
K	0.055	0.063	1.400	1.600
L	0.059 TYP.		1.500 TYP.	
M	0.108 TYP.		2.750 TYP.	

### ■ Suggested Pad Layout

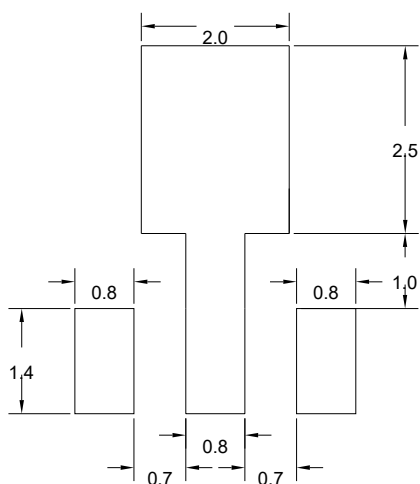

UNIT:MM



## 2SA1213-Y

---

### Disclaimer

The information presented in this document is for reference only. Yangzhou Yangjie Electronic Technology Co., Ltd. reserves the right to make changes without notice for the specification of the products displayed herein to improve reliability, function, or design or otherwise.

The product listed herein is designed to be used with ordinary electronic equipment or devices, and not designed to be used with equipment or devices which require high level of reliability and the malfunction of which would directly endanger human life (such as medical instruments, transportation equipment, aerospace machinery, nuclear-reactor controllers, fuel controllers and other safety devices), Yangjie or anyone on its behalf, assumes no responsibility or liability for any damages resulting from such improper use of sale.

This publication supersedes & replaces all information previously supplied. For additional information, please visit our website [http:// www.21yangjie.com](http://www.21yangjie.com) , or consult your nearest Yangjie's sales office for further assistance.